

描述 / Descriptions

表面贴装瞬态电压抑制器功率：600W,反向浪涌电压：6.8V~550V，SMBF 封装。

Surface mount transient voltage suppressor power 600 watts,Stand-Off Voltage：6.8V~550V，SMBF package.

特征 / Features

玻璃钝化，低电感，适用表面贴装。无卤产品。

Glass passivated junction, Low inductance, For surface mounted applications. HF product.

用途 / Applications

一般用途。

General purpose.

内部等效电路 / Equivalent Circuit

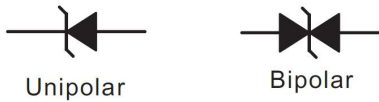

引脚排列 / Pinning



单极性

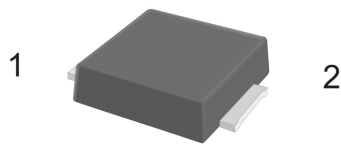

双极性

PIN	DESCRIPTION
1	Cathode
2	Anode

The recommended mounting pad size

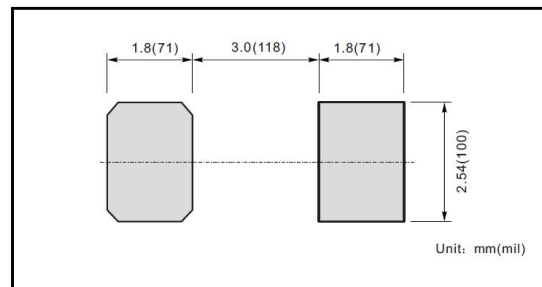

印章代码 / Marking

见印章说明。See Marking Instructions.

极限参数 / Absolute Maximum Ratings(Ta=25°C)

参数 Parameter	符号 Symbol	数值 Rating	单位 Unit
Peak Pulse Power Dissipation on 10/1000 s waveform (Note1,Note2, Fig.1).	P _{PPM}	600	W
Peak Forward Surge Current,8.3ms Single Half Sine-Wave Superimposed on Rated Load, (JEDEC Method) (Note 3,Fig4).	I _{FSM} (UNI)	100	A
Peak Pulse Current on 10/1000 us waveform (Note 1, Fig 3)	I _{PPM}	see Table 1	A
Typical Junction capacitance at VR=4V, f=1MHz	C _J	390	pF
ESD Voltage per IEC6100-4-2	Contact	V _{ESD1}	±30 KV
	Air	V _{ESD2}	±30 KV
Typical Thermal Resistance Junction to Ambient(Note 2)	R _{θJA}	100	°C/W
Operating Junction Temperature and Storage Temperature Range	T _j , T _{stg}	-55 ~ +150	°C

Note:

1. Non-repetitive current pulse, per Fig.3 and derated above T_A = 25°C per Fig. 2.
2. Mounted on 5 mm² (0.13mm thick) land areas.
3. Measured on 8.3ms,single half sine-wave or equivalent square wave,duty cycle=4 pulses per minute maximum
4. Peak pulse power waveform is 10/1000μS.

电性能参数 / Electrical Characteristics(Ta=25°C)

Type		Reverse Stand-off Voltage	Breakdown Voltage		Test Current	Maximum Reverse Leakage	Max. Clamp Voltage	Peak Pulse Current	Package	
			V _{BR} @ I _T						SMBF	
		V _{RRM}	Min	Max	I _T	V _C @ I _{PP}	I _{PP}	Device Marking Ccode	UNI	BI
UNI	BI	V	V	V	mA	uA	V	A	UNI	BI
P6SMBF6.8A	P6SMBF6.8CA	5.8	6.45	7.14	10	1000	10.5	58.1	6V8A	6V8C
P6SMBF7.5A	P6SMBF7.5CA	6.4	7.13	7.88	10	500	11.3	54	7V5A	7V5C
P6SMBF8.2A	P6SMBF8.2CA	7.02	7.79	8.61	10	200	12.1	50.4	8V2A	8V2C
P6SMBF9.1A	P6SMBF9.1CA	7.78	8.65	9.55	1	50	13.4	45.5	9V1A	9V1C
P6SMBF10A	P6SMBF10CA	8.55	9.5	10.5	1	10	14.5	42.1	10A	10C
P6SMBF11A	P6SMBF11CA	9.4	10.5	11.6	1	5	15.6	39.1	11A	11C
P6SMBF12A	P6SMBF12CA	10.2	11.4	12.6	1	5	16.7	36.5	12A	12C
P6SMBF13A	P6SMBF13CA	11.1	12.4	13.7	1	1	18.2	33.5	13A	13C
P6SMBF15A	P6SMBF15CA	12.8	14.3	15.8	1	1	21.2	28.8	15A	15C
P6SMBF16A	P6SMBF16CA	13.6	15.2	16.8	1	1	22.5	27.1	16A	16C
P6SMBF18A	P6SMBF18CA	15.3	17.1	18.9	1	1	25.5	24.2	18A	18C
P6SMBF20A	P6SMBF20CA	17.1	19	21	1	1	27.7	22	20A	20C
P6SMBF22A	P6SMBF22CA	18.8	20.9	23.1	1	1	30.6	19.9	22A	22C
P6SMBF24A	P6SMBF24CA	20.5	22.8	25.2	1	1	33.2	18.4	24A	24C
P6SMBF27A	P6SMBF27CA	23.1	25.7	28.4	1	1	37.5	16.3	27A	27C
P6SMBF30A	P6SMBF30CA	25.6	28.5	31.5	1	1	41.4	14.7	30A	30C
P6SMBF33A	P6SMBF33CA	28.2	31.4	34.7	1	1	45.7	13.3	33A	33C
P6SMBF36A	P6SMBF36CA	30.8	34.2	37.8	1	1	49.9	12.2	36A	36C
P6SMBF39A	P6SMBF39CA	33.3	37.1	41	1	1	53.9	11.3	39A	39C
P6SMBF43A	P6SMBF43CA	36.8	40.9	45.2	1	1	59.3	10.3	43A	43C
P6SMBF47A	P6SMBF47CA	40.2	44.7	49.4	1	1	64.8	9.4	47A	47C
P6SMBF51A	P6SMBF51CA	43.6	48.5	53.6	1	1	70.1	8.7	51A	51C
P6SMBF56A	P6SMBF56CA	47.8	53.2	58.8	1	1	77	7.9	56A	56C
P6SMBF58A	P6SMBF58CA	52.78	55.1	60.9	1	1	79.8	7.7	58A	58C
P6SMBF62A	P6SMBF62CA	53	58.9	65.1	1	1	85	7.2	62A	62C
P6SMBF68A	P6SMBF68CA	58.1	64.6	71.4	1	1	92	6.6	68A	68C
P6SMBF75A	P6SMBF75CA	64.1	71.3	78.8	1	1	103	5.9	75A	75C

电性能参数 / Electrical Characteristics(Ta=25°C)

Type		Reverse Stand-off Voltage	Breakdown Voltage		Test Current	Maximum Reverse Leakage	Max. Clamp Voltage	Peak Pulse Current	Package	
			V _{BR} @ I _T						SMBF	
		V _{RRM}	Min	Max	I _T	V _C @ I _{PP}	I _{PP}	UNI	BI	
UNI	BI	V	V	V	mA	uA	V	A	UNI	BI
P6SMBF82A	P6SMBF82CA	70.1	77.9	86.1	1	1	113	5.4	82A	82C
P6SMBF91A	P6SMBF91CA	77.8	86.5	95.5	1	1	125	4.9	91A	91C
P6SMBF100A	P6SMBF100CA	85.5	95	105	1	1	137	4.5	100A	100C
P6SMBF110A	P6SMBF110CA	94	105	116	1	1	152	4	110A	110C
P6SMBF120A	P6SMBF120CA	102	114	126	1	1	165	3.7	120A	120C
P6SMBF130A	P6SMBF130CA	111	124	137	1	1	179	3.4	130A	130C
P6SMBF150A	P6SMBF150CA	128	143	158	1	1	207	2.9	150A	150C
P6SMBF160A	P6SMBF160CA	136	152	168	1	1	219	2.8	160A	160C
P6SMBF170A	P6SMBF170CA	145	162	179	1	1	234	2.6	170A	170C
P6SMBF180A	P6SMBF180CA	154	171	189	1	1	246	2.5	180A	180C
P6SMBF200A	P6SMBF200CA	171	190	210	1	1	274	2.2	200A	200C
P6SMBF220A	P6SMBF220CA	185	209	231	1	1	328	1.9	220A	220C
P6SMBF250A	P6SMBF250CA	214	237	263	1	1	344	1.8	250A	250C
P6SMBF300A	P6SMBF300CA	256	285	315	1	1	414	1.5	300A	300C
P6SMBF350A	P6SMBF350CA	300	332	368	1	1	482	1.3	350A	350C
P6SMBF400A	P6SMBF400CA	342	380	420	1	1	548	1.1	400A	400C
P6SMBF440A	P6SMBF440CA	376	418	462	1	1	602	1	440A	440C
P6SMBF480A	P6SMBF480CA	408	456	504	1	1	658	0.9	480A	480C
P6SMBF510A	P6SMBF510CA	434	485	535	1	1	698	0.9	510A	510C
P6SMBF530A	P6SMBF530CA	451	503.5	556.5	1	1	725	0.8	530A	530C
P6SMBF540A	P6SMBF540CA	460	513	567	1	1	740	0.8	540A	540C
P6SMBF550A	P6SMBF550CA	468	522.5	577.5	1	1	760	0.8	550A	550C

电参数曲线图 / Electrical Characteristic Curve

Fig.1 Peak Pulse Power Rating Curve

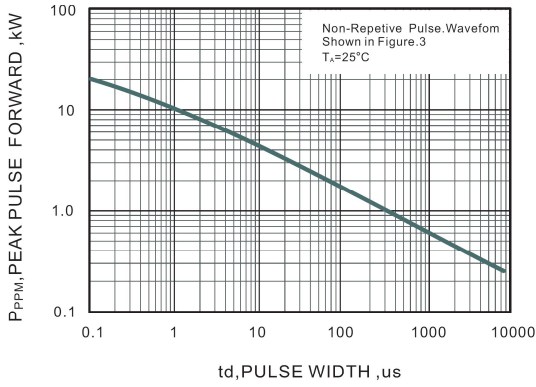

Fig.2 Forward Current Derating Curve

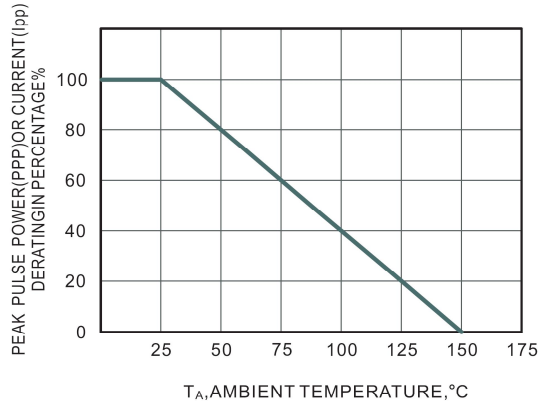

Fig.3 Pulse Waveform

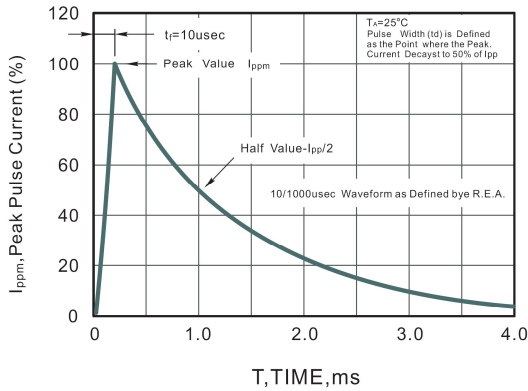
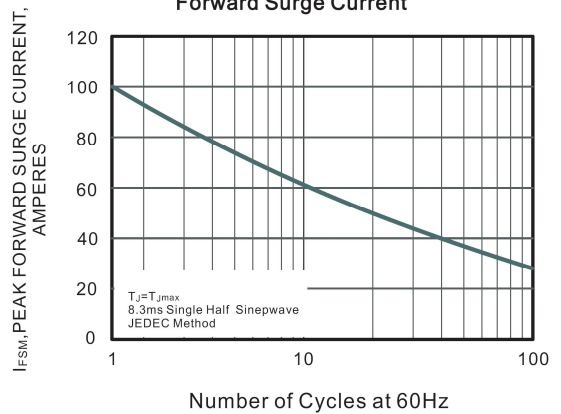
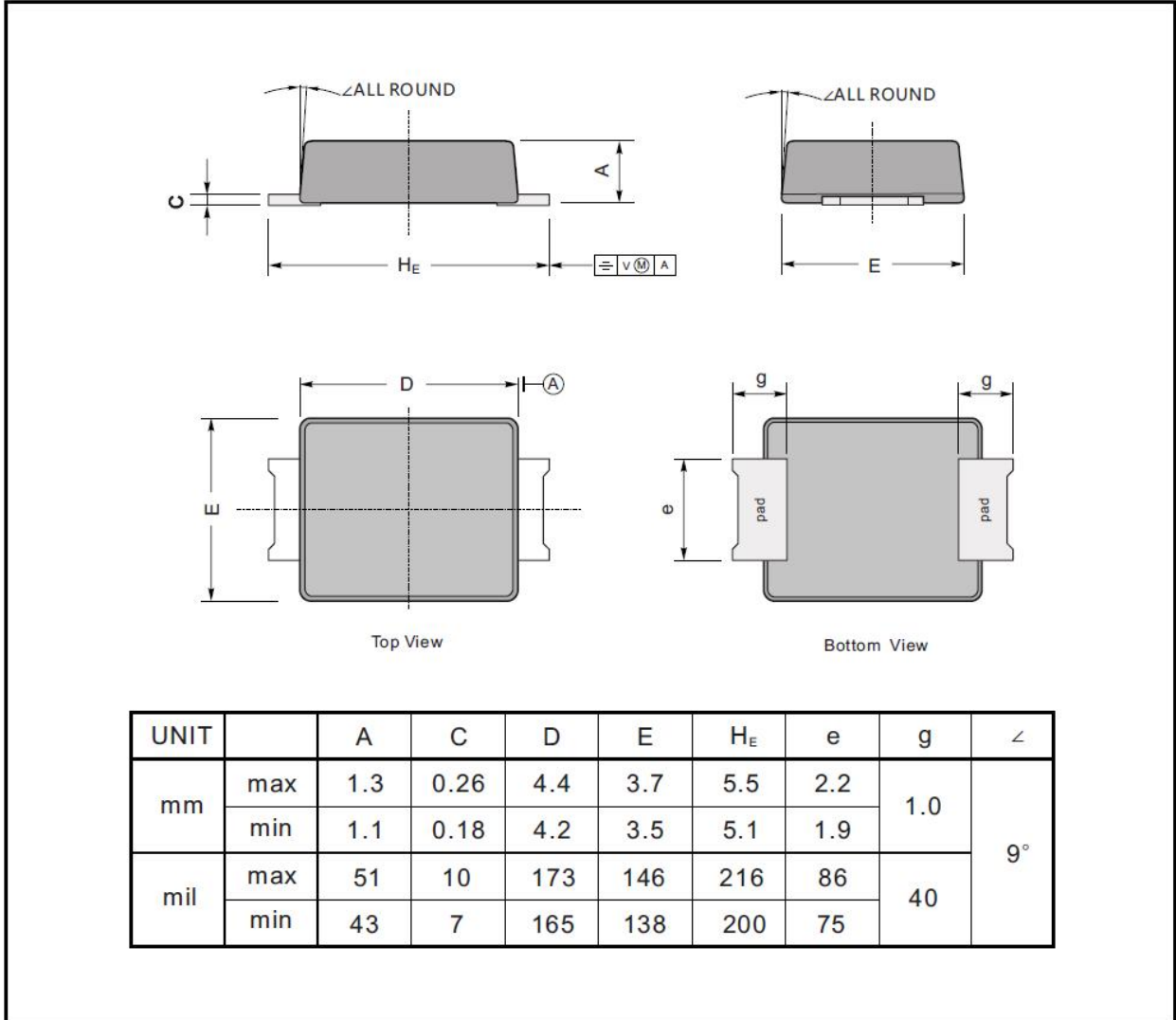

Fig.4 Maximum Non-Repetitive Peak Forward Surge Current



外形尺寸图 / Package Dimensions

SMBF



单极性印章图

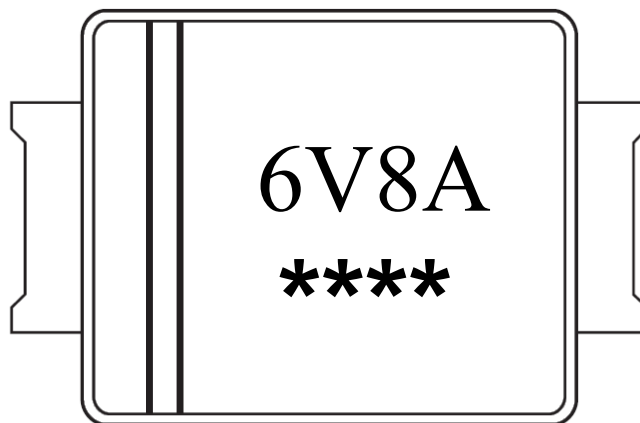

说明：

6V8A : 为型号代码

**** : 为生产批号追溯码，第1个*为年月代码，后面3个*为当月小批号代码

Note:

6V8A : Product Type Code

**** : Lot No. Code ,The 1st * means:YM Code ,The last 3 * means:little Lot No
Code

双极性印章图

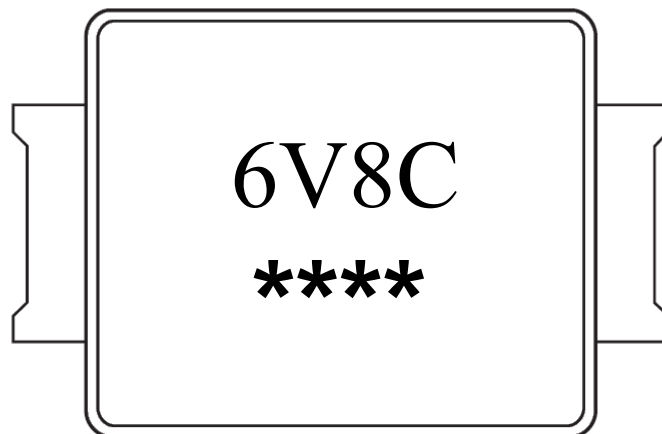

说明：

6V8C : 为型号代码

**** : 为生产批号追溯码，第1个*为年月代码，后面3个*为当月小批号代码

Note:

6V8C : Product Type Code

**** : Lot No. Code ,The 1st * means:YM Code ,The last 3 * means:little Lot No Code

回流焊温度曲线图(无铅) / Temperature Profile for IR Reflow Soldering(Pb-Free)

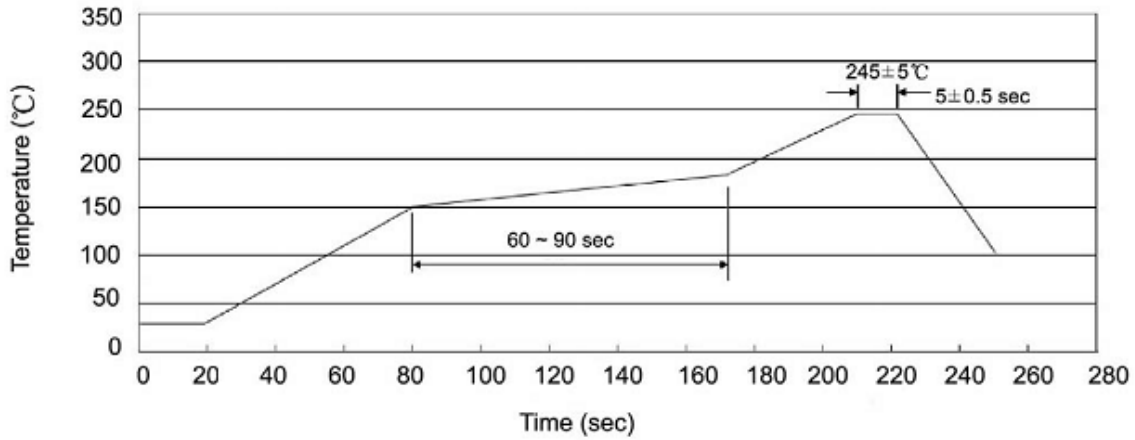

说明：

- 1、预热温度 150 ~ 180°C，时间 60 ~ 90sec;
- 2、峰值温度 245±5°C，时间持续为 5±0.5sec;
- 3、焊接制程冷却速度为 2 ~ 10°C/sec.

Note:

- 1.Preheating:150~180°C, Time:60~90sec.
- 2.Peak Temp.:245±5°C, Duration:5±0.5sec.
3. Cooling Speed: 2~10°C/sec.

耐焊接热试验条件 / Resistance to Soldering Heat Test Conditions

温度：260±5°C

时间：10±1 sec.

Temp.:260±5°C

Time:10±1 sec

包装规格 / Packaging SPEC.

卷盘包装 / REEL

Package Type 封装形式	Units 包装数量					Dimension 包装尺寸 (unit: mm ³)		
	Units/Reel 只/卷盘	Reels/Inner Box 卷盘/盒	Units/Inner Box 只/盒	Inner Boxes/Outer Box 盒/箱	Units/Outer Box 只/箱	Reel	Inner Box 盒	Outer Box 箱
SMBF	5000	2	10000	5	50000	13" ×15	336X332X40	380X335X366

使用说明 / Notices